

NON-CONTROLLED COPY

INFORMATION SUBJECT TO CHANGE WITHOUT NOTICE

COPY WILL NOT BE UPDATED

COPY ISSUED BY.....

COPY ISSUED ON.....

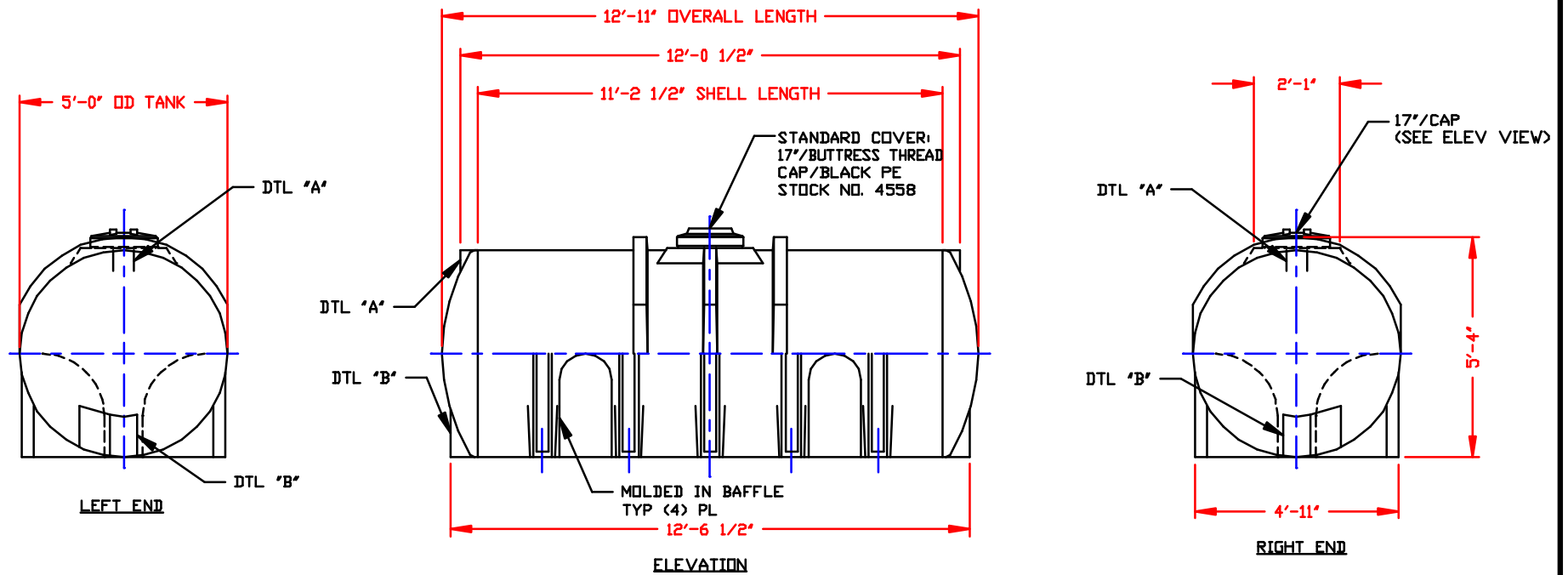

NOTES

1. THIS IS A COMPUTER GENERATED DWG. DO NOT REVISE BY HAND.
2. DIMENSIONS WILL VARY ±3% DUE TO VARIATIONS IN MULTIPLE MOLDS & CONDITIONS PREVALENT DURING MANUFACTURE & USAGE.
3. MOLDED IN GALLONAGE MARKERS IN BOTH ENDS STARTING @ 200 GAL UP TO 1600 GAL IN 200 GAL INCREMENTS. AVOID WHEN PLACING FITTINGS.

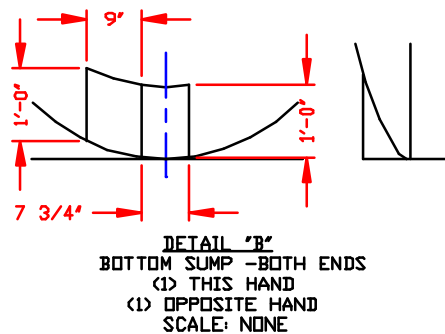
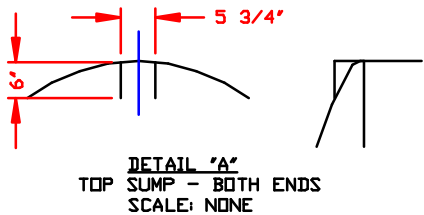

CALCULATED CAPACITY	VOLUME IN U.S. GALLONS
DESIGN CAPACITY	1765

CONFIDENTIAL PROPERTY OF
POLY PROCESSING COMPANY
NOT FOR REPRINT OR USE
WITHOUT PERMISSION

DWG TITLE		1750 GALLON HORIZONTAL LEG TANK	
SCALE:	3/8"=1'-0"		DR: MB WILKERSON
DATE:	4/13/00		CK: J. BRANTLEY
SHEET		COMPUTER FILE	REV
1 OF 1		13401750	-